



LOCATION	TELEPHONE	FAX
AKG Fellow Subsidiaries (Germany)		
Hofgeismar	Autokühler GmbH & Co. KG	+49 5 67 1-88 3-0
Hofgeismar	AKG Thermotechnik International GmbH & Co. KG	+49 5 67 1-88 3-0
Hofgeismar	AKG Thermotechnik GmbH & Co. KG	+49 5 67 1-31 98
Appenweier	Autokühler GmbH & Co. KG	+49 7 80 5-498-0
Dortmund	AKG Thermotechnik GmbH & Co. KG	+49 2 31-92 15 50
Uslar	AKG Thermotechnik GmbH & Co. KG	+49 5 57 1-92 46-0
AKG Fellow Subsidiaries (International)		
China	AKG Thermal Systems (Taicang) Co., Ltd.	+86 (-512) 535-69-4 18
France	AKG France S.A.S.	+33 3 87 95 11 11
Great Britain	AKG UK Limited	+44 14 43-67 80 50
Singapore	AKG Trading	+65 96 26 36 17
Turkey	AKG-SRF A. S.	+90 2 32-26 55-169
USA	AKG of America, Inc.	+1 919-563-42 86
USA	AKG Thermal Systems, Inc.	+1 919-563-48 71
AKG Authorized Dealers (Germany)		
Dortmund	Brenscheidt Autokühler GmbH	+49 2 31-93 11 93-0
Freiberg a. N.	SLB GmbH Industriekühler	+49 7 14 1-290 902
Mönchengladbach	Michael Widler Filtration und Kühlung	+49 2 16 1-960 287
Mühlhausen	Kammer Antriebs- und Steuerungstechnik	+49 3 60 1-44 40 13
München	Kühlerbau Schneider GmbH & Co. Betriebs KG	+49 89-54 70 10 66
Neubrandenburg	Lippold Hydraulik & Wälzlager GmbH	+49 3 95-36 302-20
Oberweser-Gottstreu	Hega Antriebstechnik	+49 5 57 4-18 42
Rielasingen	Salzmann	+49 77 31-8684-5
AKG Sales Representatives and Authorized Dealers (Europe)		
Austria	mfk-Tech	+43-31 43 20 51 41 2
Bulgaria	IOW Bulgaria Ltd.	+359 2 961 72 60
Czech Republic	IOW Bohemia	+420-545 217 911
Finland	Nestepaine	+358 9-61 36 33
France	Domange Hydrauliques	+33-1-46 88 46 46
Italy	Elle.Bi.	+39 02 939 00 326
Poland	IOW Trade	+48 76 85 22 117
Slovenia	Agis-Klima d. o. o.	+386 62 77 14 64
Spain	NovaHydra	+34 943 645 927
Sweden	AB Pegol	+46 31-24 74 10
Switzerland	Autokühler AG, Switzerland	+41 1 840 65 00
Ukraine	Gespaso	+38-044-537 0464
AKG Sales Representatives (World)		
Australia	Fluid Dynamics	+61 3 97 96 59 88
Brazil	Apema	+55 11 756 25 77
India	Alkraft	+91 44 625 87 90
Malaysia	Alra Radiator	+603 836 81 00
South Africa	Entramarc (PTY) LTD.	+27 11 704-6708
South Korea	Global	+82 32 87 20 401

AKG – A World Class Supplier

The AKG group is one of the biggest suppliers of aluminium heat exchangers for industrial use world-wide.

Coolers and cooling systems for various applications are manufactured in Germany and at many international production sites.

Hydraulic Coolers – Made by AKG



AKG Thermotechnik International GmbH & Co. KG
 Postfach 1346
 D-34363 Hofgeismar
 telephone (49) 56 71 / 8 83-0
 fax (49) 56 71 / 35 82
 Internet: <http://www.akg-group.com>
 E-Mail: Info@akg-group.com

AKG - edition 2005-1-E (changes and errors excepted)

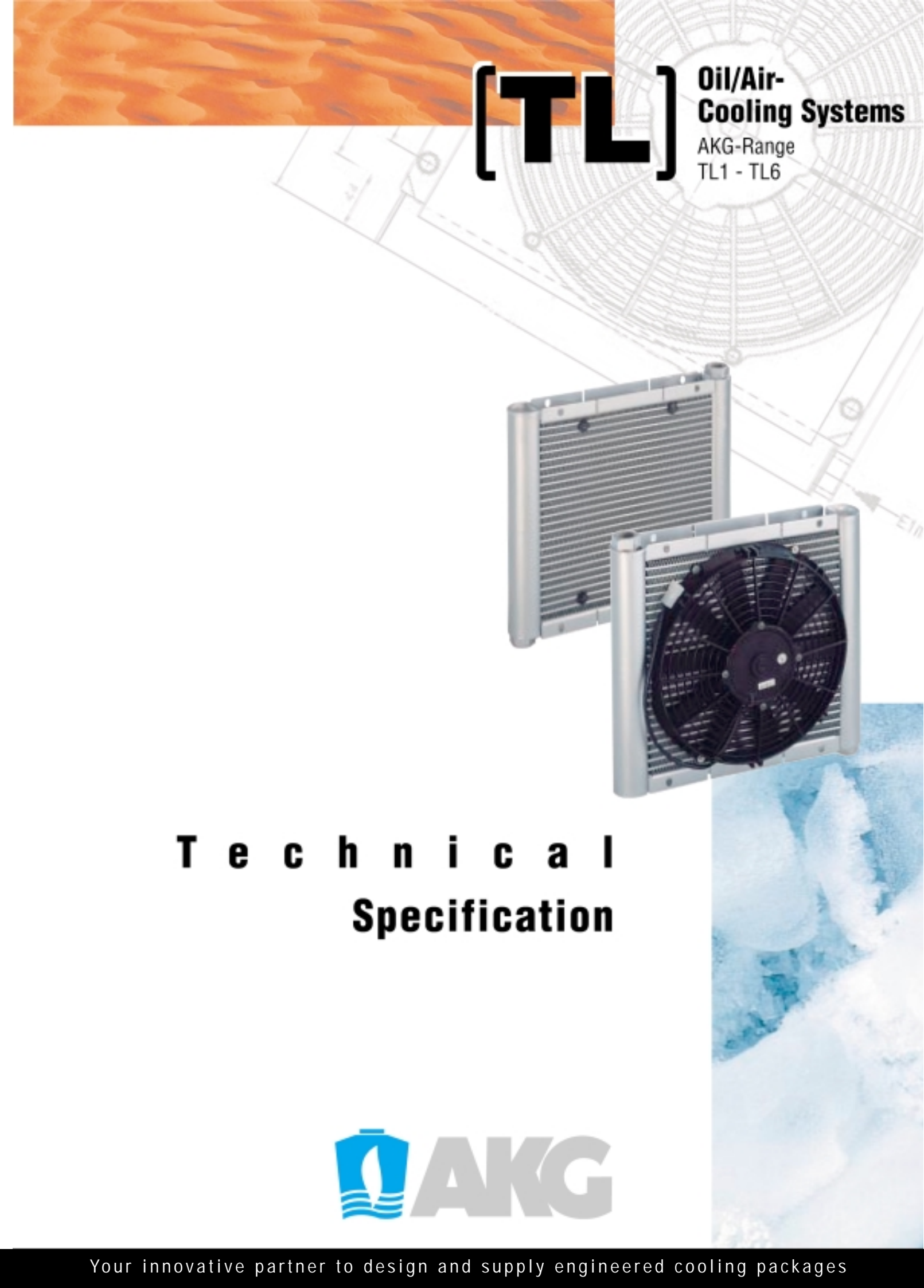

Technical Specification



Your innovative partner to design and supply engineered cooling packages

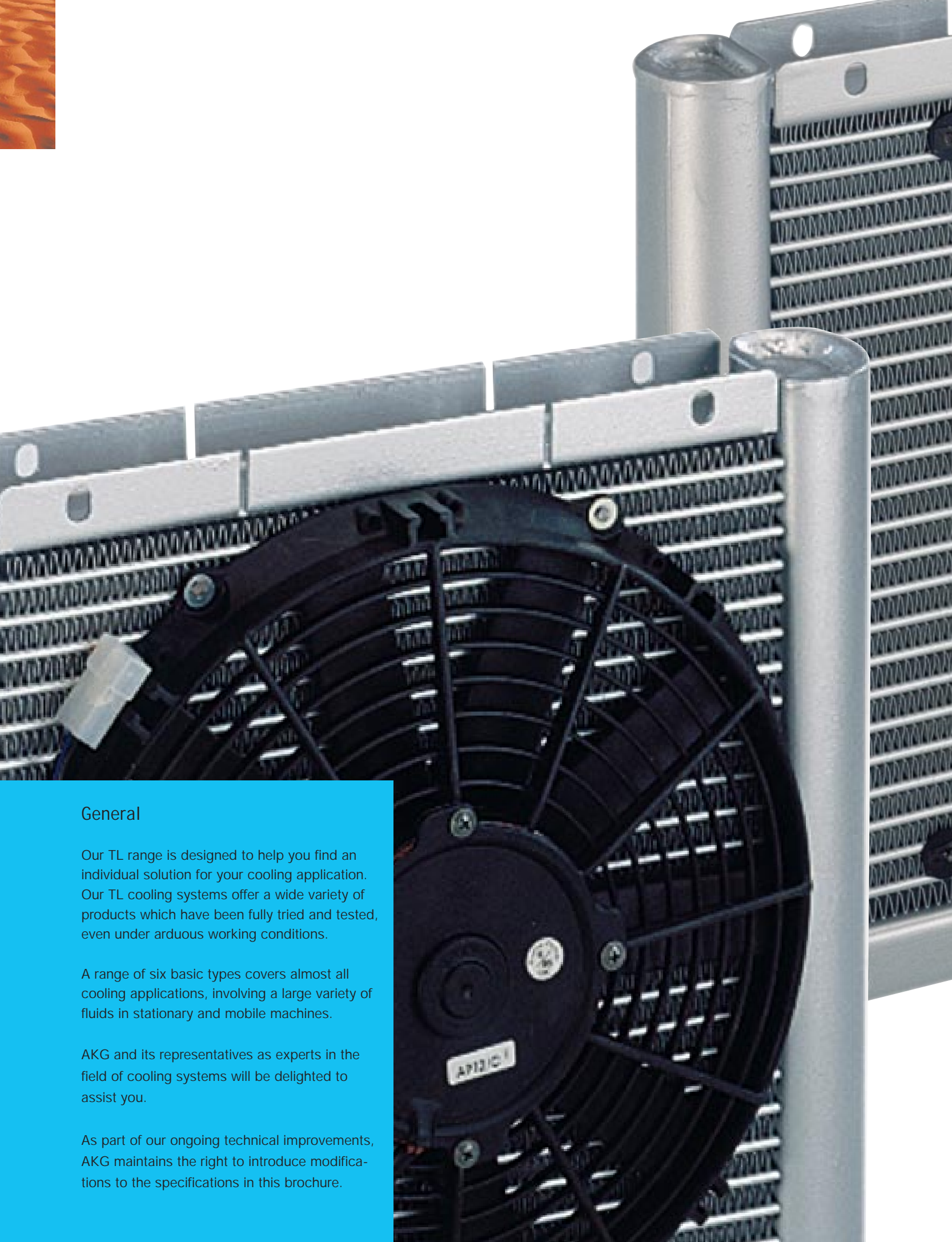

Oil/Air-Cooling Systems

AKG-Range
TL1 - TL6

Features

- Cooling systems are made from Aluminium
- Fully tried and tested for arduous working conditions
- Ideal for mobile machines
- Maximum working pressure 14 bar
- Offering a high flexibility for usage in transmission, hydraulic, engine and lubrication oils
- Cooling systems can be fitted with 12/24V DC and 3 Phase motors

Benefits

- Short lead times
- Cost effective
- Cooling systems fully equipped for immediate use
- Easy to install
- Spares from stock
- Maintenance free

(TL)

General

Our TL range is designed to help you find an individual solution for your cooling application. Our TL cooling systems offer a wide variety of products which have been fully tried and tested, even under arduous working conditions.

A range of six basic types covers almost all cooling applications, involving a large variety of fluids in stationary and mobile machines.

AKG and its representatives as experts in the field of cooling systems will be delighted to assist you.

As part of our ongoing technical improvements, AKG maintains the right to introduce modifications to the specifications in this brochure.

Applications

The units can be used for cooling: mineral oil, synthetic oil, bio oil, HFA B C D liquids, water/glycol mixture, containing 50% antifreeze and corrosion inhibitors

Function: Heat will be transferred from the fluid to the cooling air flow

- Please note:
- Set up and operating instructions
 - General Terms of Sales and Delivery
 - Spares list

Technical Data

TL1 - TL6, with DC fan motor, ... including shroud without shroud 3 Phase motor

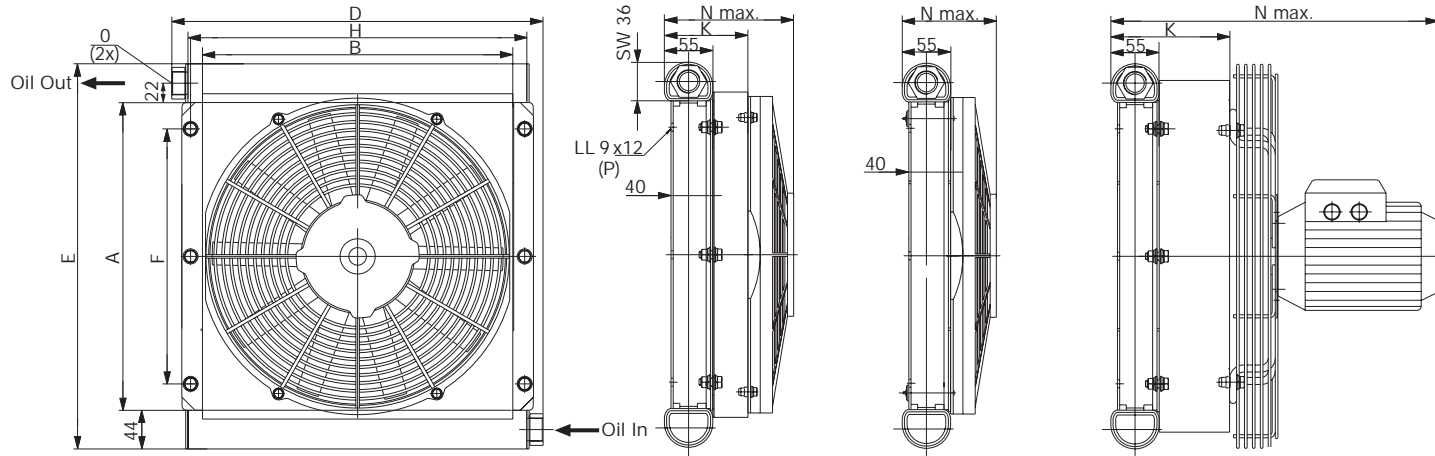

SPECIFICATION							
Cooler Type	TL1	TL2	TL3	TL4	TL5	TL6	
Heat rejection ¹⁾	1-4,5	2-7	3-13	5-16	6-20	10-35	
DIMENSIONS							
TL1-TL6, with DC fan motor, including shroud							
A	mm	150	200	250	300	350	600
B	mm	154	203	252	301	350	301
D	mm	227	276	325	372	422	374
E	mm	238	288	338	388	438	688
F	mm	1 x 90	1 x 140	1 x 190	1 x 240	2 x 145	2 x 270
H	mm	184	233	282	331	380	331
K	mm		95	95	95	95	95
N max.	mm	145,5	147	147	147	147	147
O		G 1/2	G 3/4	G 3/4	G 3/4	G 3/4	G 3/4
P	mm	4x	4x	4x	4x	6x	6x
A x B	m ²	0.0231	0.0406	0.0630	0.0902	0.1223	0.1804
Without shroud							
N max.	mm	-	107	107	107	107	107
3 Phase motor							
K	mm	-	135	112	112	135	255
N max.	mm		180	320	320	380	510

ORDER CODE SYSTEM

574 . 2 . 0000

Cooler type: e.g. 2 = TL2

Direction of cooling air flow: pulling

- 01 = 12 V DC including shroud
- 02 = 24 V DC including shroud
- 03 = 3 Phase motor including shroud
- 21 = 12 V DC without shroud
- 22 = 24 V DC without shroud

Cooler Type	Order Number	Fan Diameter [mm]	Fan Speed [rpm]	Noise Level [dB(A), 1m]	Motor Voltage [V]	Current [Amp]	Power Consumption [kW]	Volume [l]	Working Pressure [bar]	Total Weight excluding fluid [kg]
TL1	5741.201.0000	140	4780	68	12	3.4	0.04	0.7	14	2.4
	5741.202.0000	140	4770	68	24	1.7	0.04	0.7	14	2.4
TL2	5742.201.0000	167	4250	76	12	6.5	0.08	1.0	14	4.4
	5742.202.0000	167	4350	76	24	3.6	0.09	1.0	14	4.4
	5742.221.0000	167	4250	77	12	6.5	0.08	1.0	14	3.6
	5742.222.0000	167	4350	77	24	3.6	0.09	1.0	14	3.6
	5742.203.0000	170	1500	63	230/400	0.12	0.04	1.0	14	5.6
TL3	5743.201.0000	225	3400	76	12	7.7	0.09	1.1	14	5.5
	5743.202.0000	225	3260	76	24	3.9	0.09	1.1	14	5.5
	5743.221.0000	225	3400	76	12	7.7	0.09	1.1	14	4.6
	5743.222.0000	225	3260	76	24	3.9	0.09	1.1	14	4.6
	5743.203.0000	250	3000	81	230/400	0.79	0.25	1.1	14	12.0
TL4	5744.201.0000	280	3280	80	12	9.2	0.12	1.7	14	7.4
	5744.202.0000	280	3260	80	24	4.7	0.12	1.7	14	7.4
	5744.221.0000	280	3280	79	12	9.2	0.12	1.7	14	6.2
	5744.222.0000	280	3260	79	24	4.7	0.12	1.7	14	6.2
	5744.203.0000	280	3000	82	230/400	0.79	0.25	1.7	14	14.0
TL5	5745.201.0000	330	2600	75	12	7.9	0.10	2.0	14	8.3
	5745.202.0000	330	2620	75	24	4.1	0.10	2.0	14	8.3
	5745.221.0000	330	2600	71	12	7.9	0.10	2.0	14	7.0
	5745.222.0000	330	2620	71	24	4.1	0.10	2.0	14	7.0
	5745.203.0000	350	1500	72	230/400	0.5	0.12	2.0	14	15.0
TL6	5746.201.0000	2 x 280	3280	85	12	2 x 9.2	2 x 0.12	2.4	14	13.0
	5746.202.0000	2 x 280	3260	85	24	2 x 4.7	2 x 0.12	2.4	14	13.0
	5746.221.0000	2 x 280	3280	81	12	2 x 9.2	2 x 0.12	2.4	14	14.0
	5746.222.0000	2 x 280	3260	81	24	2 x 4.7	2 x 0.12	2.4	14	14.0
	5746.203.0000	1 x 300	3000	81	230/400	1.0	0.37	2.4	14	20.0

3 Phase motor: B14 small flange
Depending on the motor the current and power will vary.
For details see the name plate.

Materials

- Cooler: Aluminium
- Fan blade: Plastic
- Shroud, Finger guard: Steel (Zinc plated), Painted/Powder coated

1) For details use diagrams and tables as appropriate
2) All systems are pressure tested according to DIN 50104

Easy sizing of TL-coolers

The following tables may be used to quickly select a TL-cooler.

The data is based on the assumption that oil inlet temperature does not exceed 70 °C for hydraulic and 110 °C for lubrication applications.

Please use the following heat rejection figures if no details are available:

- Agricultural and construction machinery: 1/3 of Diesel engine power
- Hydraulic pumps driven by an electric motor: 1/3 of electric motor power

Hydraulic applications

Heat rejection [kW @ 30 °C ambient temperature]											
Oil flow in l/min	TL1	TL2	TL3	TL4	TL5	TL6	TL2	TL3	TL4	TL5	TL6
Including shroud						Without shroud, fitted with 12/24V DC fan motor					
10	1.8										
20	2.0	3.0	4.8	6.8	8.4	12.8	2.2	3.2	6.0	6.2	10.4
30	2.2	3.2	5.2	7.0	8.6	13.2	2.4	3.6	6.2	6.4	10.8
50		3.4	5.6	7.2	8.8	14.0	2.6	4.2	6.6	6.8	11.6
60		3.6	5.8	7.4	9.0	14.4	2.8	4.4	6.8	7.2	12.2
80			6.4	7.6	9.2	15.2		4.8	7.0	7.4	13.0
100				8.0	9.4	16.0			7.2	7.8	13.2
120					9.6	16.2				8.0	13.6
150						16.4					14.4

Heat rejection [kW @ 40 °C ambient temperature]											
Oil flow in l/min	TL1	TL2	TL3	TL4	TL5	TL6	TL2	TL3	TL4	TL5	TL6
Including shroud						Without shroud, fitted with 12/24V DC fan motor					
10	1.4										
20	1.5	2.3	3.6	5.1	6.3	9.6	1.7	2.4	4.5	4.7	7.8
30	1.7	2.4	3.9	5.3	6.5	9.9	1.8	2.7	4.7	4.8	8.1
50		2.6	4.2	5.4	6.6	10.5	2.0	3.2	5.0	5.1	8.7
60		2.7	4.4	5.6	6.8	10.8	2.1	3.3	5.1	5.4	9.2
80			4.8	5.7	6.9	11.4		3.6	5.3	5.6	9.8
100				6.0	7.1	12.0			5.4	5.9	9.9
120					7.2	12.2				6.0	10.2
150						12.3					10.8

Easy sizing of TL-coolers

For a more detailed and customised cooler selection exact temperatures and flows are necessary.

Please select your cooler according to the example on page 10 or seek advice from AKG or its representatives.

Lubrication oil applications

Heat rejection [kW @ 30 °C ambient temperature]											
Oil flow in l/min	TL1	TL2	TL3	TL4	TL5	TL6	TL2	TL3	TL4	TL5	TL6
Including shroud						Without shroud, fitted with 12/24V DC fan motor					
10	3.6										
20	4.0	6.0	9.6	13.6	16.8	25.6	4.4	6.4	12.0	12.4	20.8
30	4.4	6.4	10.4	14.0	17.2	26.4	4.8	7.2	12.4	12.8	21.6
50		6.8	11.2	14.4	17.6	28.0	5.2	8.4	13.2	13.6	23.2
60		7.2	11.6	14.8	18.0	28.8	5.6	8.8	13.6	14.4	24.4
80			12.8	15.2	18.4	30.4		9.6	14.0	14.8	26.0
100				16.0	18.8	32.0			14.4	15.6	26.4
120					19.2	32.4				16.0	27.2
150						32.8					28.8

Heat rejection [kW @ 40 °C ambient temperature]											
Oil flow in l/min	TL1	TL2	TL3	TL4	TL5	TL6	TL2	TL3	TL4	TL5	TL6
Including shroud						Without shroud, fitted with 12/24V DC fan motor					
10	3.2										
20	3.5	5.3	8.4	11.9	14.7	22.4	3.9	5.6	10.5	10.9	18.2
30	3.9	5.6	9.1	12.3	15.1	23.1	4.2	6.3	10.9	11.2	18.9
50		6.0	9.8	12.6	15.4	24.5	4.6	7.4	11.6	11.9	20.3
60		6.3	10.2	13.0	15.8	25.2	4.9	7.7	11.9	12.6	21.4
80			11.2	13.3	16.1	26.6		8.4	12.3	13.0	22.8
100				14.0	16.5	28.0			12.6	13.7	23.1
120					16.8	28.4				14.0	23.8
150						28.7					25.2

Specific heat rejection TL1 - TL6

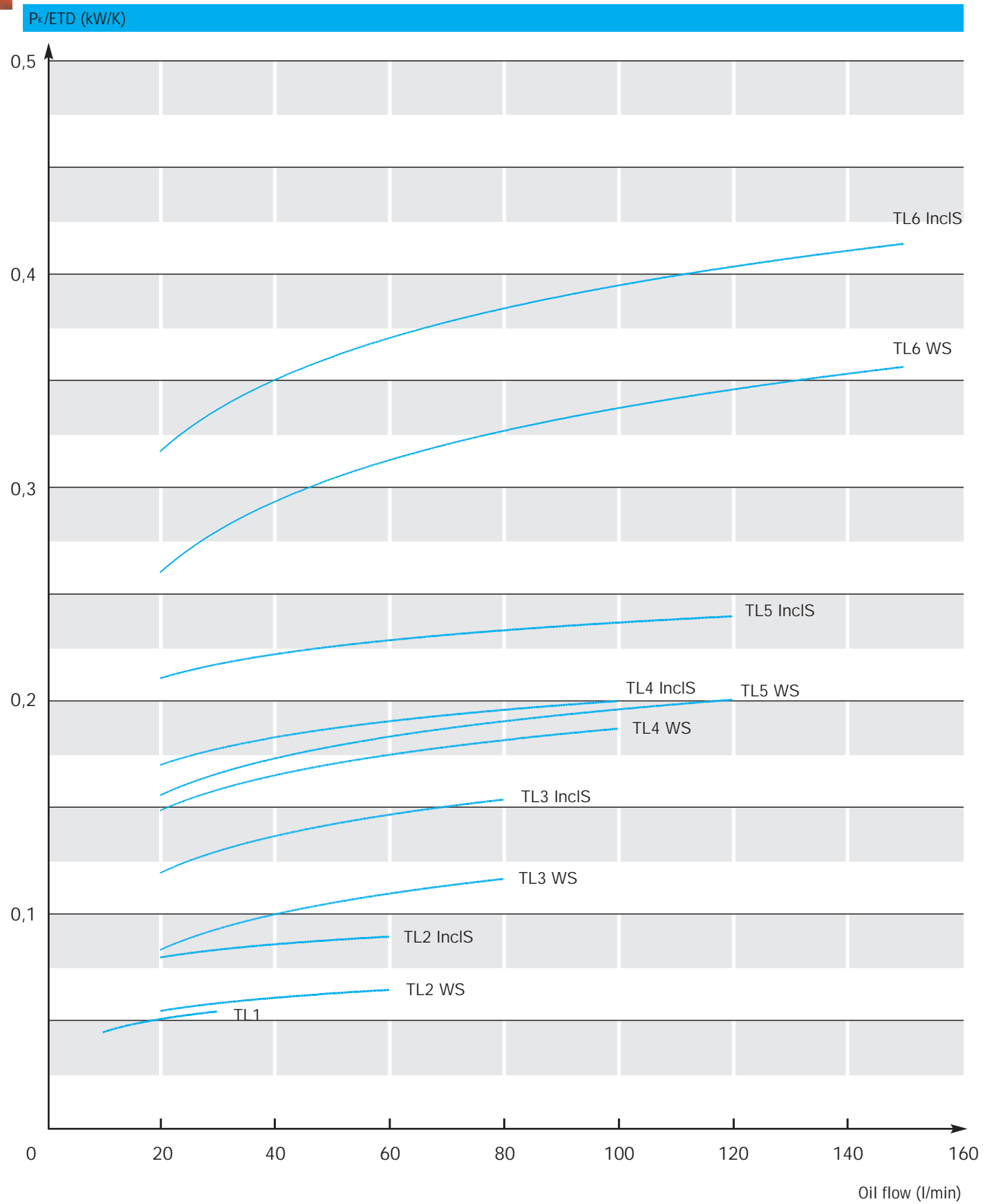

InclS = Including shroud
 WS = Without shroud

Pressure drop TL1 - TL6

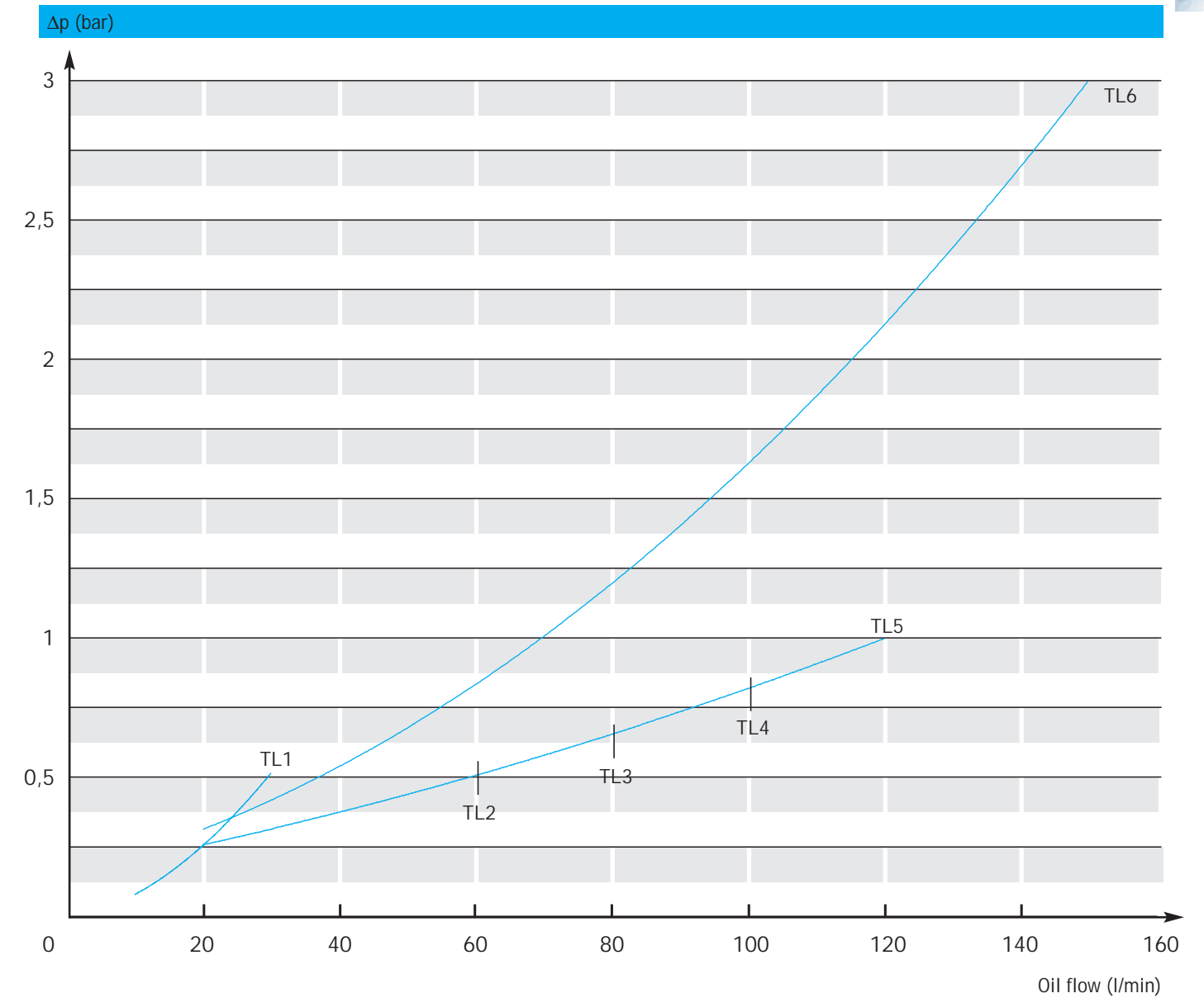

The pressure drop curves are based on a viscosity of 30 mm²/s = 30 cSt.
 Please use conversion factor f from page 11, to calculate pressure drop at other viscosity's.

Selecting a cooling system

To select a cooler for your application, the following data is required:

- Heat rejection: Alternative terminology is dissipation
- Oil flow: Circulating oil flow determines the cooler size
- Oil inlet temperature: Temperature of the oil entering the cooler
- Cooling air flow temperature: Air temperature at cooler face before entering matrix

1. Determination of input data

P_{req} [kW]	Heat rejection
V_{oil} [l/min]	Oil flow
T_{oil} [°C]	Oil inlet temperature
T_{caf} [°C]	Cooling air flow temperature

Example

P_{req} = 10 kW
V_{oil} = 50 l/min
T_{oil} = 70 °C
T_{caf} = 30 °C

2. Specific heat rejection

ETD [K] = $T_{oil} - T_{caf}$ Entering Temperature Difference
 P_{shr} [kW/K] = P_{req} / ETD required specific heat rejection

ETD [K] = $T_{oil} - T_{caf} => 70\text{ °C} - 30\text{ °C} = 40\text{ °C} (= 40\text{ K})$
 $P_{shr} = P_{req} / ETD => 10\text{ kW} / 40\text{ K} = 0.25\text{ kW/K}$

3. Select according to diagram

P_{shr}/ETD [kW/K] actual specific heat rejection
 $P = (P_{shr} / ETD) \times ETD$ actual heat rejection

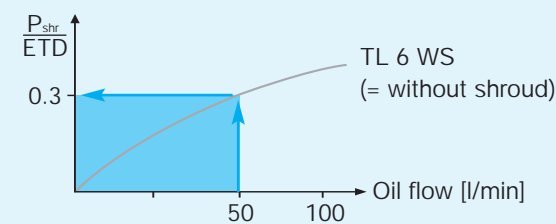

$P_{shr} / ETD = 0.3\text{ kW/K} => TL6\text{ WS}$
 $P = 0.3\text{ kW/K} \times 40\text{ K} = 12\text{ kW}$

4. Pressure drop / Oil temperature difference

Obtain pressure drop @ 30 cSt oil viscosity from diagram on page 9. To calculate for other oil viscosities please use example on page 11.

$$\Delta T_{oil} [°C] = 33 \times P[kW] / V_{oil} [l/min]$$

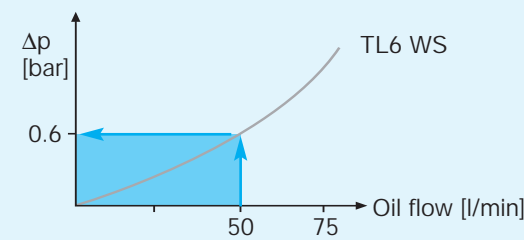

$$\Delta T_{oil} = 33 \times (12\text{ kW} / 50\text{ l/min}) = 7.9\text{ °C}$$

5. Results

selected cooler TL6 WS: heat rejection 12 kW,
 oil temperature difference 7.9 °C,
 pressure drop 0.6 bar

Conversion factors for different oil pressure drops

The pressure drop curves on pages 9 are based on a viscosity of 30 mm²/s = 30 cSt.
 Please use conversion factor f to calculate pressure drop at other viscosities.

$\frac{mm^2}{s}, cSt$	10	15	20	30	40	50	60	80	100
f	0.5	0.65	0.75	1.0	1.2	1.4	1.6	2.1	2.8

Example:

Pressure drop of type TL4 is 0.75 bar @ 90 l/min and 30 mm²/s.
 Assume an oil type ISO VG 46 is used @ 60 °C having a viscosity of 20 mm²/s.
 To calculate new pressure drop multiply 0.75 bar by f = 0.75 to obtain the actual pressure drop 0.6 bar approximately.

Notes: